

Centrometal

HEATING TECHNIQUE

Centrometal d.o.o. - Glavna 12, 40306 Macinec, Croatia, tel: +385 40 372 600, fax: +385 40 372 611

TECHNICAL INSTRUCTIONS



for **installation**, use and
maintenance of pellet stove



CentroPelet ZS10

Carefully read the precautions and follow the procedures correctly.



WARNING!

Do not try to install the stove;
Always contact authorized and trained personnel.

- **In case of breakage or poor functioning always contact the Authorized Assistance Centre;** any attempt to remove parts or perform maintenance on the device can expose the user to electrical shock danger. The stove contains parts whose maintenance must be done by the Authorized Assistance Centre.
- **The stove is a heating device;** its parts reach extreme temperatures and contact without adequate protection can provoke burns of various degrees.
Pay particular attention to children.
- **In case of a transfer, contact the Authorized Assistance Centre for the removal and new installation.**
- **Do not insert fingers or other objects in the air flow exit slits.**
Inside the device there is a high speed fan that could cause grave personal injury. Pay particular attention to children.
- **Do not remain for long periods directly exposed to the flow of hot air.**
Direct and prolonged exposition to the cold air could be hazardous to health. Pay particular attention in rooms where there are children, the elderly or the ill.
- **In case the stove functions poorly, shut down the device immediately, unhook the appropriate automatic switch and contact the Authorized Assistance Centre.** The continued use of the device in said conditions can cause fires or flashes.
- If you do not use the auxiliary air outlet (only for models with canalisation), check that the fan speed is set on zero (deactivated).

WARNING!

- **During the stove installation operation, keep children out of the work area to avoid unforeseen accidents.**
- **Do not block or cover in any way the body of the stove or obstruct the slits placed on the upper side.**
Obstructing said slits can cause fires.
- **Do not use the stove in areas containing precision devices or works of art.**
The quality of the conserved objects may deteriorate.
- **Do not expose animals or plants to direct air flow from the unit.**
Prolonged direct exposition to the flow of air from the stove can have negative effects on plants and animals.
- **Occasionally ventilate the room during the use of the device.**
Insufficient ventilation can be the origin of insufficient oxygen in the room.
- **Do not expose the stove to contact with water.**
The electrical insulation could be damaged, with the consequent possibilities of electrocution and breakage due to the thermal extremes.
- **Verify the installation conditions to locate eventual damage.**
After the stove has completed 900 hours of operation (the lower screen will read "SErV"), contact the Authorized Assistance Centre for cleaning and ordinary maintenance.
- Do not use inflammable gas near the stove.
- **Unhook the automatic switch if the device will not be used for long periods of time.**
- We check the start up of all our stoves.

GB Norms and conformity declarations

Legislation

- Our company declares that the stove conforms to the following norms for EC European Directive marking.
- 89/336 EC and 2004/108 EC (EMC directive) and successive amendments.
- 2006/95 EC (low voltage directive) and successive amendments.
- 2006/42 EC (machinery directive).
- 89/106 EC (construction products).
- For installation in Italy refer to the UNI 10683/98 or successive modifications; the technician installing the hydrothermal sanitary system will issue the declaration of conformity according to L. 37/2008. The installation of appliance has to be in accordance with local and national laws and with European norms.
- EN 60335-1 - EN 50165 - EN 50366 - EN 55014-1 - EN 61000-3-2 - EN 61000-3-3 - EN 14785.

Responsibility

The manufacturer declines every direct or indirect, civil or penal responsibility due to:

- Poor maintenance.
- Failure to observe the instructions contained in the manuals.
- Use in non-conformity with the safety directives.
- Installation in non-conformity with the norms in force in the country.
- Installation by unqualified or untrained personnel.
- Modifications and repairs not authorized by the manufacturer.
- Use of non-original replacement parts.
- Exceptional events.
- Use of pellets not approved by the manufacturer.

Installation

Flue

The flue must meet the following requirements:

- No other type of chimney, stove, boiler or hood vent must be connected (fig.1).
- It must be adequately distanced from combustible or inflammable material by means of an air cavity or opportune insulation.

- The internal section must be uniform, preferably circular: the square or rectangular sections must have rounded corners with a radius of no less than 20 mm, a maximum relationship between the sides of 1.5; the walls as smooth as possible with no narrowed sections, regular curves and no discontinuities, with deviations from the axis not more than 45°.

Fig.1: methods for installing the flue

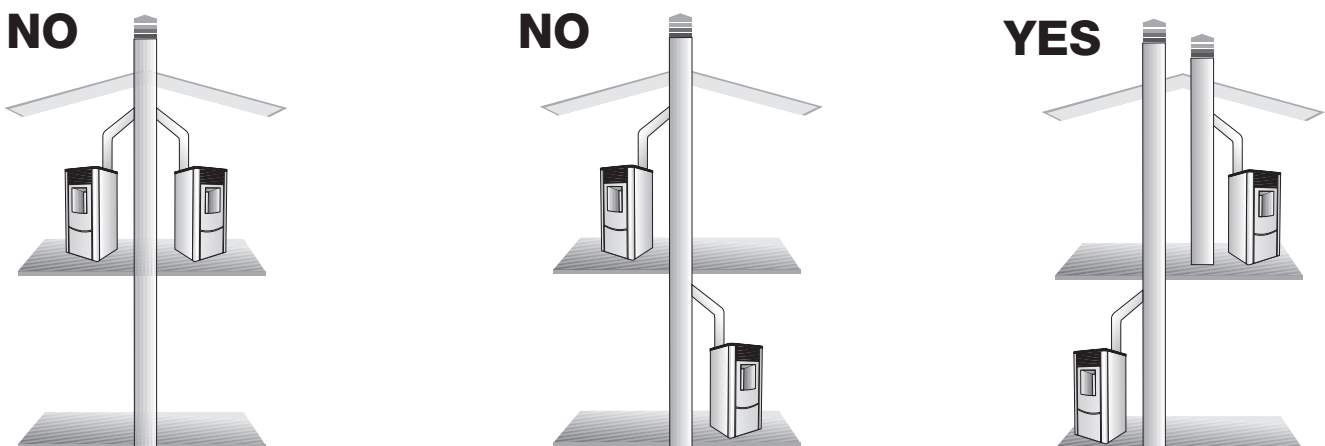

- Every device must have its own flue with a diameter equal to or larger than the stove's smoke clearing tube and a height not less than that declared.
- Never use two stoves, a chimney and a stove, a stove and a wood kitchen, etc in the same environment, since the draught of one could damage the draught of the other.
- Collective type ventilation ducts that can lower the atmospheric pressure in the installation environment are not permitted, even if installed in environments that are adjacent to and communicating with the locale of the installation.
- It is forbidden to make fixed or mobile openings in the flue to connect devices different from that for which it is originally intended.
- It is forbidden to pass other air feeding channels or tubes for electrical system usage through the flue, even if oversized.
- It is advisable that the flue be furnished with a chamber which collects solid material and eventual condensation situated below the vertical entrance to the flue so that it is easily opened and inspected through the air-tight door.
- Whenever flues with parallel exits are used it is advisable to raise the upwind chamber by one element.
- The chimney tube must never pass across a combustible surface.

The Chimney Cap

The chimney cap must respect the following requirements:

- It must have the equivalent diameter and internal form of the flue.
- It must have a useful outlet diameter of not less than double that of the flue.
- The chimney cap on the roof or that remains in contact with the outside (for example, in case of open lofts or attics), must be covered with elements in brick or tile and must, in any case, be well insulated.
- It must be constructed to prevent rain, snow, and extraneous bodies from entering the flue

and so that the discharge of the products of combustion is not inhibited by wind from any quarter or strength (wind-proof chimney cap).

- The chimney cap must be positioned in such a way as to guarantee the adequate dispersion and dilution of the products of combustion and in any case, must be out of the reflux zone. This zone has different dimensions and forms according to the angle of inclination of the roof so it is necessary to adopt minimum heights (Fig. 2).
- The chimney cap must be a wind-proof type and must be above the ridge.
- Eventual structures or other obstacles that are higher than the chimney cap must not be too close to the chimney cap itself.

Fig.2: characteristics of the chimney cap

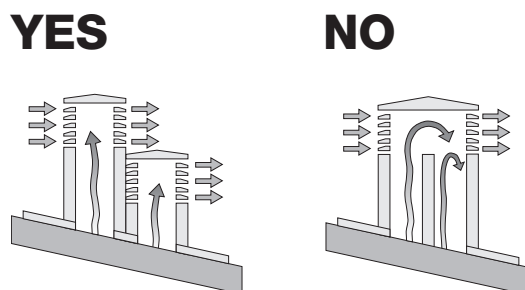

Canalisation (if available)

Before you connect the auxiliary pipes for the canalisation of the air, please check that:

- the canalisation system is according to law.
- the system does not present any obstructions.
- once you connect the stove and switch on the auxiliary fan, there is a regular air flow at the end of the canalisation.
- you can use up to two hot air delivery pipes with a maximum length of 4 m. each. If you use only one pipe, the maximum length is 5 m. In this second case, the unused outlet must be properly blocked.
- The piping and conduit must be protected with fixed, non-reclosable grids or suitable covers. The minimal section must not be reduced anyway.
- Both the piping and grids must be made of a material able to carry hot air up to a maximum temperature of 80°C.

Smoke discharge

The discharge system must be for the stove only (it is not permissible to discharge into flues in common with other devices).

The smoke discharge takes place through the 8 cm diameter tube placed at the back.

A “T” with a condensation collection cap should be provided. The smoke discharge of the stove must be connected with the outside using a steel or black tube (resistant up to 450°C) without obstructions. The tube must be hermetically sealed. To make the tubes airtight and for their eventual insulation, it is necessary to use material resistant up to at least 300°C (silicone or putty for high temperatures).

The horizontal sections can be up to 2 m long. It is possible to have up to three 90° curves.

If the discharge tube does not insert in the flue, an opportunely fastened vertical section of at least 1.5 m is necessary (except for evident safety contraindications) and a windproof termination. The vertical duct can be inside or outside. If the smoke duct is outside it must be insulated. If the smoke duct is inserted in a flue, this must be certified for solid combustibles and if it is larger than 150 mm in diameter, modification is necessary by inserting a tube and sealing the discharge with respect to the parts in brickwork.

External air intake

The stove must be furnished with the air necessary to guarantee the regular functioning of the combustion and an environmental well being.

- Be sure that the room where the stove is installed has sufficient aeration and, if necessary, install an air intake duct with a minimum recommended diameter of 50 mm to bring in air from the outside.
- The external air intake must communicate with the stove and positioned so that it is not obstructed. It must be protected with a permanent non-closable grill or other suitable protection provided that the minimum diameter is not reduced.

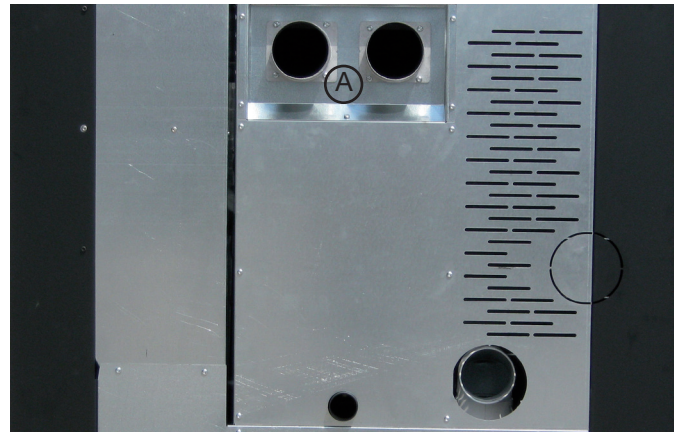

A. Horizontal air duct
B. Discharge of smoke

It must be possible to inspect all the sections of the smoke duct. If it is a fixed duct it must have openings for inspection and cleaning.

According to the norm UNI 10683/98, the stove must not be in the same environment where extractors, type B gas devices or in any case, devices that create lower atmospheric pressure in the locale are found.

The adjacent locale must not be used as a garage or be a space without ventilation or air exchange, a storage area for combustible material or used for an activity that has a fire hazard.

- The air flow can also be acquired from a locale adjacent to where the stove is installed as long as that flow can freely cross the permanent non-closable openings that communicate with the outside.
- The presence in the local adjacent to where the stove is installed, of other devices in use or of suction devices that cause a contrary draught effect must not create a lower air pressure in the locale than in the outside environment.
- In the adjacent locale the permanent openings must respond to the requisites which are listed in the points above.

Sizing of the pellet stove

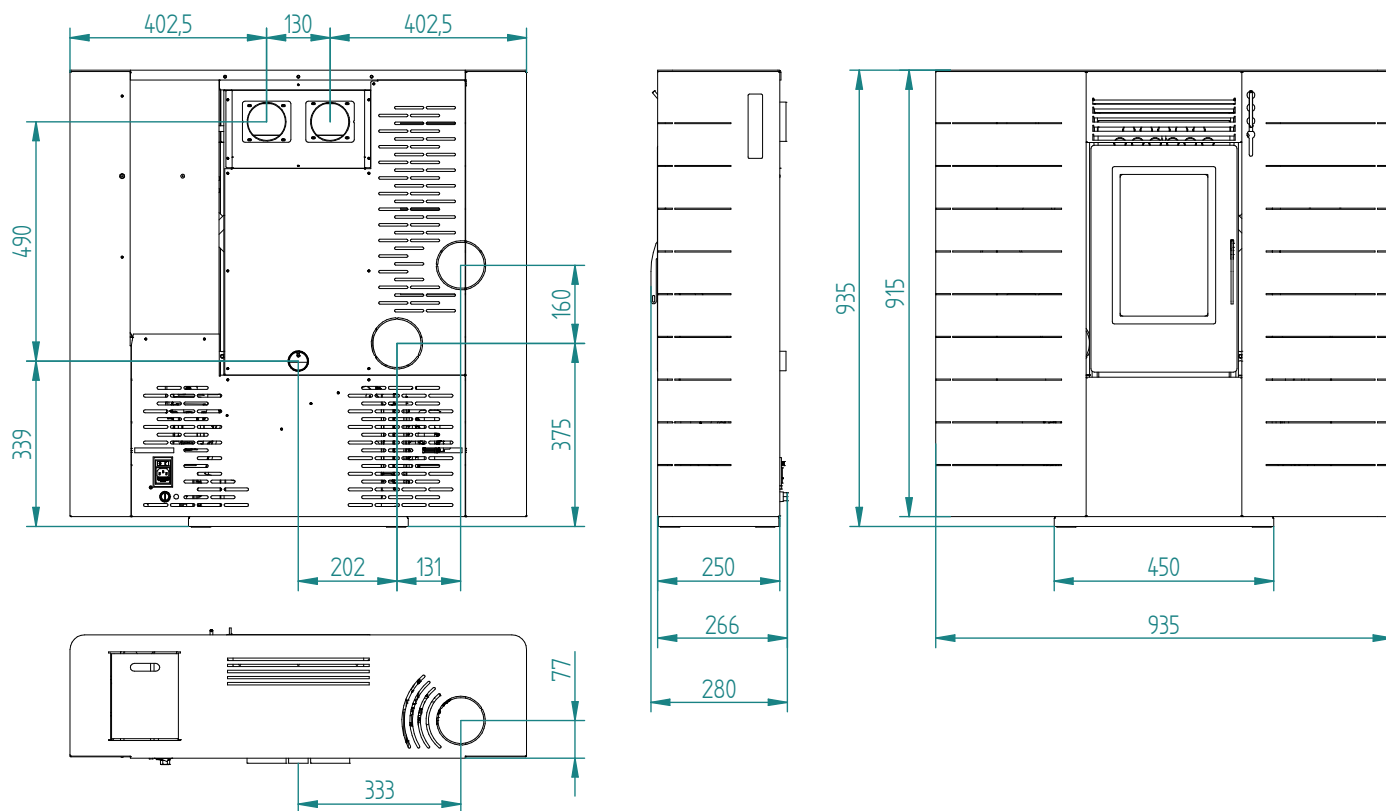

Fig.5: sizing of the pellet stove mod. 90

The stove is furnished with an electrical cable to connect to a 230V 50Hz socket, preferably with a thermal-magnetic switch. Variations in tension of more than 10% can compromise the stove (if not already present, an adequate differential switch should be provided).

The electrical system must comply with the norms; verify in particular the efficiency of the ground circuit. The electrical feed cable must be of a diameter adequate to the power of the device.

The stove must be completely level. Verify the weight bearing capacity of the flooring.

The placement of the stove within the living environment is determined so that the environment is heated in a uniform manner. Before deciding where to place the stove, keep in mind that:

- The air used for combustion must not come from a garage or a space without ventilation or air exchange, but from a free space or the outside;
- The stove should not be installed in a bedroom;
- Rather it is preferable to install the stove in a large, central room of the house to insure the maximum heat circulation;
- A grounded electrical connection is obligatory (if the cable issued with the stove is not long enough to reach the closet socket, use an extension cable along the floor).

Fire Safety Distance

The stove must be installed respecting the following safety conditions:

- Minimum distance from the sides and the back must be 40 cm from moderately inflammable material;
- Easily inflammable material must not be placed closer than 80 cm in front of the stove;
- If the stove is installed on an inflammable pavement the stove must be placed on a slab of material that insulates it from the heat that is wider at the sides by 20 cm and in the front by 40 cm;
- Do not place objects in inflammable material or any material that can compromise the operation of the stove on the stove or within the safety distance;
- In addition, it is advisable to keep all elements of combustible or inflammable material such as beams, wooden furniture, drapes, inflammable liquids, etc. outside the radiance area of the stove, and in any case at least 1 m from the heating block (Fig. 6);
- In case of connection to wooden walls or other inflammable material, it is necessary to insulate the smoke discharge tube with ceramic fibre or another material with the same characteristics.

Fig. 6: minimum distance of objects

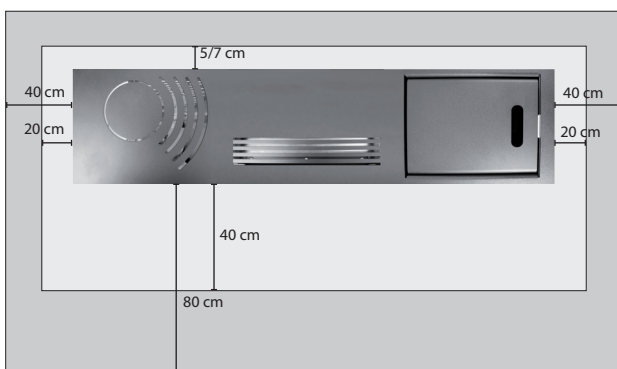

Minimum aeration for comburant air intake

The combustion air must be taken from the outdoor ambience absolutely.

For a correct and safe placement of the air intake all the measures and prescriptions (Fig. 7) must be respected. There are distances to respect to prevent the comburant air from being subtracted from another source: for example the opening of a window could cause eddies in the outside air subtracting it from the stove

Fig. 7: distance from walls

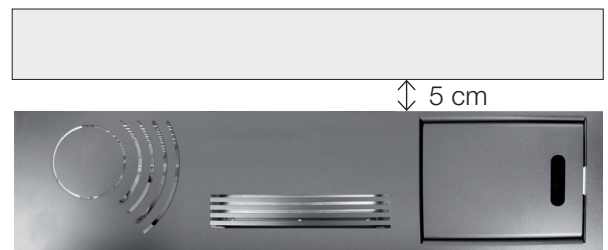

- Before lighting the stove, carefully read the use and maintenance manual.
- Remove from the tank all the tools that were inserted during packaging and be sure that the tank is free of eventual extraneous bodies.
- Unroll the environmental probe placed on the rear of the stove, without placing it on the heated parts of the stove.
- Correctly connect the pellet stove to the flue.
- Fill the tank with 6mm diameter pellets.
- Open the door and check that the basket is properly inserted in its slot and that the flame trap is located in the upper part of the combustion chamber.
- Close the door. Never open the door while the pellet stove is operating.
- Connect the stove to an outlet with the appropriate cable received with the stove.
- Place the switch on the rear of the stove at the “1” position.
- Press the  key for 2 seconds and the gearcase will begin its lighting cycle.



Fig. 8: display with 3 keys

ATTENTION!

During the first lighting it is necessary to ventilate the environment well, since during the first hours of operation unpleasant odours could develop due to fumes from the paint and the grease in the tuyère wrapping.

If during the normal operation of the stove, the temperature of the smoke reaches 220°C (parameter which can be modified by a technician) the smoke is modulated as follows:

- Smoke removal motor set at the maximum speed;
- Pellet loading gear motor at the minimum speed;
- Tangential heat exchange fan at the maximum speed.

This procedure functions to lower the temperature of the smoke. When this returns below the level of 220°C the stove will restore the speed of the three motors returning them to the settings before the level was passed.

If the electrical current cuts out, once it is restored, the display will indicate a state of anomaly and will read "Fire cool" (flame present). The suction will be increased to expel the residual smoke.

Operations to be performed by the Authorized Assistance Centre every season before the lighting.

- A general cleaning inside and outside.
- A careful cleaning of the exchange tubes.
- A careful cleaning and disincrustation of the crucible and the relative cavity.
- Clean the motors, checking the play and fastenings of the mechanisms.
- Clean the smoke channel (substitute the tube gaskets) and smoke extractor fan cavity.
- Clean pressure switch, substitute silicone tube.
- Check the probe.
- Replace the batteries in the clock on the electronic board.
- Clean, inspect and disincrust the lighting resistor compartment, replacing it if necessary.
- Clean/check the synoptic panel.
- Visually inspect the electrical cables, the connections and the electrical power cable.
- Clean the pellet container and verify the play with the screw feeder gear motor.
- Replace the door seals.
- Test functions, loading the screw feeder, lighting, 10 minutes of operation and shut down.
- Check the electrical parts and the electronic components.
- Check and possible cleaning of the canalisation.

